



# 带座轴承专家与应用解决方案代表供应商 Bearing Units Expert and Leading Supplier

**FK<sup>®</sup>**  
**带座轴承**  
销量连续多年领先  
年产销1800+万套

**FK<sup>®</sup>**  
**Bearing Units**  
Best Selling Brand  
18+ million sets per year



## FK带座轴承 FK BEARING UNITS



暖通风机  
HVAC



农机装备  
Agricultural Machine



工厂自动化  
FA



物料传送  
Material Handling

**FK-百行千业龙头企业的首选配套**

FK - The preferred supplier for leading enterprise in various industries



泛科

带座轴承专家与应用解决方案代表供应商  
Bearing Units Expert and Leading Supplier



# FK滚子带座轴承解决方案

FK SPHERICAL ROLLER BEARING UNITS SOLUTIONS



2026  
*New*



泛科轴承集团 FK Bearing Group

地址: 厦门市集美北部工业区莲塘路71-87号 / Tel: +86-592-6689010 / Fax: +86-592-6689009  
Email: export@fk-bearing.com / Web: www.fk-bearing.com



泛科

带座轴承专家与应用解决方案代表供应商  
Bearing Units Expert and Leading Supplier

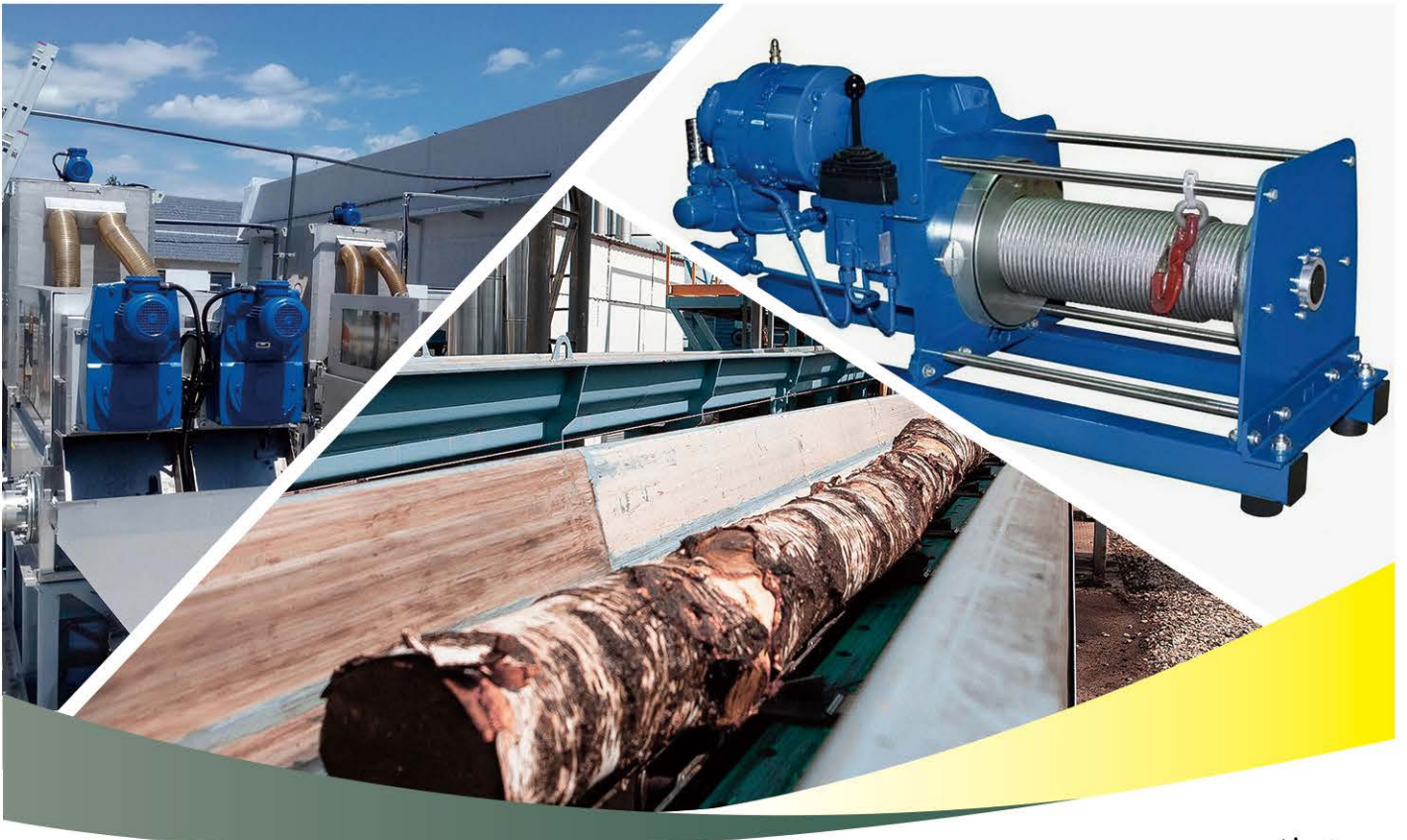

# FK巴氏合金滑动轴承解决方案

FK BABBITED SPLIT JOURNAL BEARINGS SOLUTIONS



2026  
*New*



泛科轴承集团 FK Bearing Group

地址: 厦门市集美北部工业区莲塘路71-87号 / Tel: +86-592-6689010 / Fax: +86-592-6689009  
Email: export@fk-bearing.com / Web: www.fk-bearing.com



# FK,有何不同? What make FK unique?

01 FK外球面轴承和轴承座，全过程自产  
The whole process of FK bearing and housing is self-produced

自主可控，全程溯源  
Controllable & traceable

02 FK全过程自动化生产 + 检验，数智化管理  
Automatic production and inspection with digital management

品质稳定，一致性好  
Stable quality

03 FK分别建设两种不同的生产模式：大批量与小批量  
Two different production modes for big quantity and small quantity

多少随意，敏捷交付  
Agile delivery

04 FK开创十二个针对行业特性的产品解决方案  
Twelve product solutions for specific industry

优选方案，运转无忧  
Optimal solution

05 FK一企一策提供产品解决方案  
Different solution for different company

按需定制，深度匹配  
Customized solution

06 FK同一产品，N种不同配置选择  
Multiple configuration options for same product

品质适配，节省成本  
Optimal cost

07 FK有10000+种带座轴承  
More than 10000+ types bearing units

品种齐全，一栈搞定  
Complete range

08 FK工厂仓+国内5大中心仓+国际9大中心仓  
5 domestic and 9 overseas regional warehouse

就近调配，一要就有  
Quick delivery

09 FK深耕美欧日市场二十年  
More than 20 years experience in America, Europe and Japan market

国产高端，替代进口  
Import substitution

# 中国轴承工业协会

地址：中国北京西城区马连道路4号401室  
 邮政编码：100055

电话：010-63317634  
 传真：010-63317638

## 证明

工业和信息化部办公厅：

根据工信部制造业单项冠军遴选条件要求，现就**泛科轴承集团有限公司**带座外球面球轴承产品市场占有率相关情况提供证明如下：

产品准确名称 <sup>1</sup>	带座外球面球轴承		
产品类别 (根据产品准确名称与《统计用产品分类目录》类别是否对应选择填写)	<input checked="" type="checkbox"/> 是	对应的8位或10位代码 <sup>2</sup>	3524010300
	<input type="checkbox"/> 否	是否符合行业惯例分类 <sup>3</sup>	<input checked="" type="checkbox"/> 符合行业惯例 <input type="checkbox"/> 产品过于细分，不符合行业惯例
市场占有率相关数据 <sup>4</sup>	2020年	2021年	2022年
国际市场占有率和排名	6.89% (排名第三)	7.39% (排名第三)	9.34% (排名第三)
国内市场占有率和排名	14.64% (排名第一)	14.84% (排名第一)	16.17% (排名第一)
备注	市场占有率是按产品销售数量计算。		

- 注：1.填写产品的准确规范名称。  
 2.可直接对应国家统计局《统计用产品分类目录》第四级或第五级产品类别的，填写相应的8位或10位代码。  
 3.无法对应《统计用产品分类目录》类别的，请注明是否符合行业惯例分类。  
 4.市场占有率各项相关数据按照“产品准确名称”表述的具体产品填写。排名为必填项。  
 5.本证明交企业一份，抄送中国工业经济联合会一份，有上级协会的抄送上级协会一份。

中国轴承工业协会  
 2023年10月18日

# The Biggest Manufacturer of Bearing Units in China

## 中国产销量最大的带座轴承工厂



**FK-HS** High Speed bearing units  
高速带座轴承 10000RPM



**FK-AC** HVAC Bearing Units  
暖通风机带座轴承 4000RPM



**FK-FJ** Air Handling Bearing Units  
风机带座轴承 2000RPM



**FK-HT/LT** High/Low Temperature Bearing Units  
高/低温带座轴承

HT40:400°C  
HT26:260°C  
HT20:200°C  
LT40:-40°C



**FK-MF** Maintenance Free Bearing Units  
免维护带座轴承

固体油脂  
Solid grease



**FK-AT** Free Spinning Bearing Units  
低旋转扭矩带座轴承



**FK-CR** High Corrosion Resistant Bearing Units  
高耐蚀带座轴承



**FK-SS** Stainless Steel Bearing Units  
不锈钢带座轴承  
Thermoplastic Bearing Units  
工程塑料带座轴承  
Zinc Aluminum Alloy Bearing Units  
锌铝合金带座轴承

IP69K  
Food grease  
食品油脂



**FK-CM** Customized Bearing Units  
特殊定制带座轴承



**FK-SN** Plummer Block Housing Units  
剖分式带座轴承

SNV  
SNU  
SN  
SD  
722500



**FK** Standard Bearing Units  
带座轴承

SL sealing  
L3 sealing  
F sealing  
X6 sealing



**MZD** Low Loading Application Bearing Units  
连座轴承



**FK-Agri**

Agricultural Bearings  
农机轴承



Round bore RB  
Square bore SB  
Hex bore HB

**FK-QJ**

Four-point Contact Bearings  
四点接触轴承



松土 Tillage

**FK-DRCB**

Double Row Angular Contact Bearings  
双列角接触轴承



播种 Seeding

**FK-Hub**

Agri Hub Units  
农机轮毂单元



收获 Harvesting

**FK-SFT**

Bearing with Shaft  
带轴轴承



青储 Silage making

**Relubricate Solutions**



FG grease nipple protect



FY grease nipple protect



MF 免维护 Maintenance Free



SL 自润滑 Self-Lubricating



打捆 Baling

**Sealing Solutions**



L3



R3



F



X6



MS Labyrinth Open cap



Closed cap



2 caps



烘干 Dryer



储存 Storage



**Agri Bearings**

# Packer Roller



Agri Bearings

## FK BEARING UNITS SOLUTIONS



ST  
Press Steel Housing



CI  
Casting Iron Housing



QT  
Ductile Iron Housing



ZG  
Casting Steel Housing



DG  
Forging Steel Housing



SS  
Stainless Steel Housing



PRB  
Forging Steel Housing



泛科

带座轴承专家与应用解决方案代表供应商  
Bearing Units Expert and Leading Supplier



# FK 播种机轴承解决方案

FK BEARING SOLUTIONS FOR PLANTER

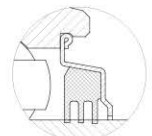

R3



AGRI

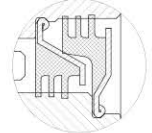

X6

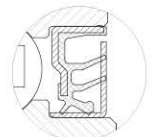

MS



泛科轴承集团 FK Bearing Group

地址: 厦门市集美北部工业区莲塘路71-87号 / Tel: +86-592-6689010 / Fax: +86-592-6689009  
Email: export@fk-bearing.com / Web: www.fk-bearing.com



带座轴承专家与应用解决方案代表供应商  
Bearing Units Expert and Leading Supplier



## FK高速静音带座轴承

FK HIGH SPEED & MUTE BEARING UNITS

替代进口 降本增效

Substitutes for premium brand  
Cost reduction and efficiency increase

HS:8000rpm

AC:4000rpm

FJ:2000rpm



泛科轴承集团 FK Bearing Group

地址: 厦门市集美北部工业区莲塘路71-87号 / Tel: +86-592-6689010 / Fax: +86-592-6689009  
Email: sales@fk-bearing.com / Web: www.fk-bearing.com



## FK免维护带座轴承应用解决方案

FK MAINTENANCE FREE BEARING UNITS SOLUTIONS



泛科轴承集团 FK Bearing Group

地址：厦门市集美北部工业区莲塘路71-87号 / Tel: +86-592-6689010 / Fax: +86-592-6689009  
Email: sales@fk-bearing.com / Web: www.fk-bearing.com



泛科

带座轴承专家与应用解决方案代表供应商  
Bearing Units Expert and Leading Supplier



## FK高耐腐蚀带座轴承解决方案

FK BEARING SOLUTIONS FOR CORROSION RESISTANT APPLICATIONS

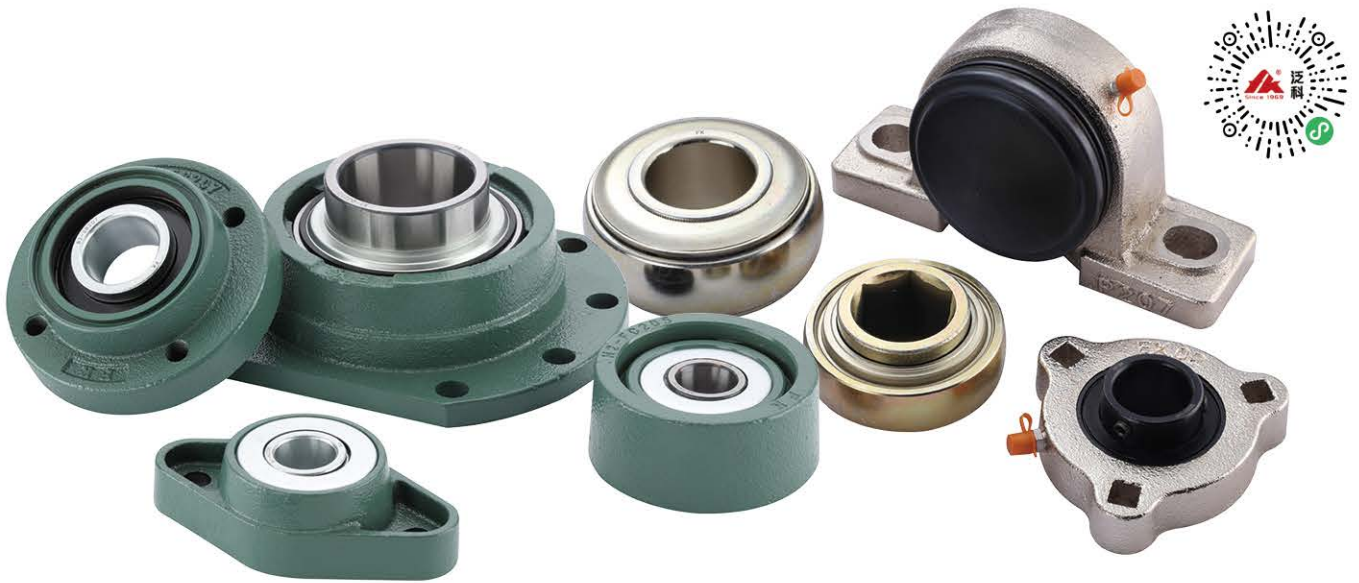

泛科轴承集团 FK Bearing Group

地址: 厦门市集美北部工业区莲塘路71-87号 / Tel: +86-592-6689010 / Fax: +86-592-6689009  
Email: sales@fk-bearing.com / Web: www.fk-bearing.com



## FK农机轮毂单元解决方案

FK AGRI HUB UNIS SOLUTIONS



泛科轴承集团 FK Bearing Group

地址: 厦门市集美北部工业区莲塘路71-87号 / Tel: +86-592-6689010 / Fax: +86-592-6689009  
Email: sales@fk-bearing.com / Web: www.fk-bearing.com



## FK养殖行业带座轴承解决方案

FK BEARING UNITS SOLUTIONS FOR STOCKBREEDING



泛科轴承集团 FK Bearing Group

地址: 厦门市集美北部工业区莲塘路71-87号 / Tel: +86-592-6689010 / Fax: +86-592-6689009  
Email: sales@fk-bearing.com / Web: www.fk-bearing.com



泛科

带座轴承专家与应用解决方案代表供应商  
Bearing Units Expert and Leading Supplier



## FK食品级带座轴承解决方案 FK FOOD GRADE BEARING UNITS SOLUTIONS

高防水 High waterproof  
食品级别 FOOD GRADE  
更易清洗 EASY CLEAN  
IP69



泛科轴承集团 FK Bearing Group

地址: 厦门市集美北部工业区莲塘路71-87号 / Tel: +86-592-6689010 / Fax: +86-592-6689009  
Email: sales@fk-bearing.com / Web: www.fk-bearing.com



泛科

带座轴承专家与应用解决方案代表供应商  
Bearing Units Expert and Leading Supplier



# FK高温带座轴承解决方案

FK HIGH TEMPERATURE BEARING UNITS

替代进口 降本增效  
Substitutes for premium brand  
Cost reduction and efficiency increase

- HT40: 400 °C
- HT26: 260 °C
- HT20: 200 °C
- LT40: -40 °C



泛科轴承集团 FK Bearing Group

地址: 厦门市集美北部工业区莲塘路71-87号 / Tel: +86-592-6689010 / Fax: +86-592-6689009  
Email: sales@fk-bearing.com / Web: www.fk-bearing.com



## FK自动化与智能化应用带座轴承解决方案

FK BEARING UNITS SOLUTIONS FOR AUTOMATIC AND INTELLIGENT APPLICATION



泛科轴承集团 FK Bearing Group

地址: 厦门市集美北部工业区莲塘路71-87号 / Tel: +86-592-6689010 / Fax: +86-592-6689009  
Email: sales@fk-bearing.com / Web: www.fk-bearing.com



泛科

带座轴承专家与应用解决方案代表供应商  
Bearing Units Expert and Leading Supplier



## FK新能源行业带座轴承解决方案

FK BEARING UNITS SOLUTIONS FOR NEW ENERGY APPLICATION

**替代进口 降本增效**

**Substitutes for premium brand**

**Cost reduction and efficiency increase**

符合锂电池产业对材料的要求

Meet the material requirements of  
lithium battery industry



泛科轴承集团 FK Bearing Group

地址：厦门市集美北部工业区莲塘路71-87号 / Tel: +86-592-6689010 / Fax: +86-592-6689009  
Email: sales@fk-bearing.com / Web: www.fk-bearing.com



## FK剖分式带座轴承 FK Plummer Block Bearing Units

替代进口 降本增效  
Substitutes for premium brand  
Cost reduction and efficiency increase

AC-SNU5: 风机级别  
铝制定位圈  
TPU制密封圈  
AC-SNU5: AC Grade  
Aluminium Locating Ring  
TPU Seal

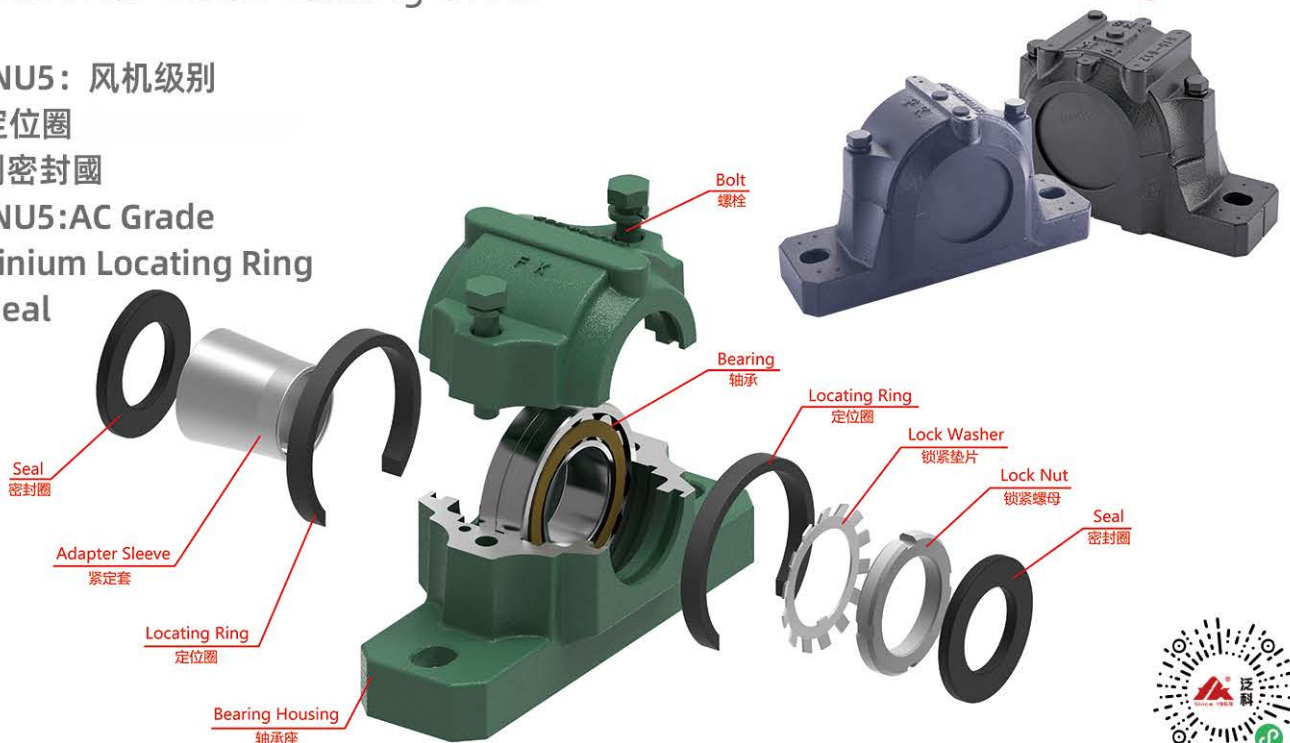

泛科轴承集团 FK Bearing Group

地址: 厦门市集美北部工业区莲塘路71-87号 / Tel: +86-592-6689010 / Fax: +86-592-6689009  
Email: sales@fk-bearing.com / Web: www.fk-bearing.com

# 销售网络 Sales network

国内：覆盖全部30个省区，6大中心仓库

Domestic: all 30 provinces, 6 regional warehouses

世界：销往70多个国家和地区，9大中心仓库

Overseas: more than 70 countries and regions, 9 regional warehouses



## FK海外 FK OVERSEAS

- ① 北美中心仓库  
North America regional warehouse: Saint-Hubert, Canada
- ② 南美中心仓库  
South America regional warehouse: Casida, Argentina
- ③ 欧洲中心仓库  
Europe regional warehouse: Stradella, Italy
- ④ 英国中心仓库  
UK warehouse: West Midland, UK
- ⑤ 俄罗斯中心仓库  
Russia warehouse: Kemerovo, Russia
- ⑥ 东南亚中心仓库  
South East Asia regional warehouse: Singapore
- ⑦ 南亚中心仓库  
South Asia regional warehouse: Delhi, India
- ⑧ 中东中心仓库  
Middle East regional warehouse: Dubai, U.A.E.
- ⑨ 非洲中心仓库  
Africa regional warehouse: Johannesburg, South Africa

## FK中国 FK CHINA

- ⑩ 总部仓库：福建南安
- ⑪ 华东中心仓库：江苏无锡
- ⑫ 华南中心仓库：广东佛山
- ⑬ 华西中心仓库：云南昆明
- ⑭ 华北中心仓库：山东济南
- ⑮ 华中中心仓库：湖北武汉

# FK不同系列产品目录 FK Catalog



FK带座轴承  
FK BALL BEARING UNITS



FK风机带座轴承  
FK AIR HANDLING BEARING UNITS



FK剖分式轴承座  
FK PLUMMER BLOCK HOUSING UNITS

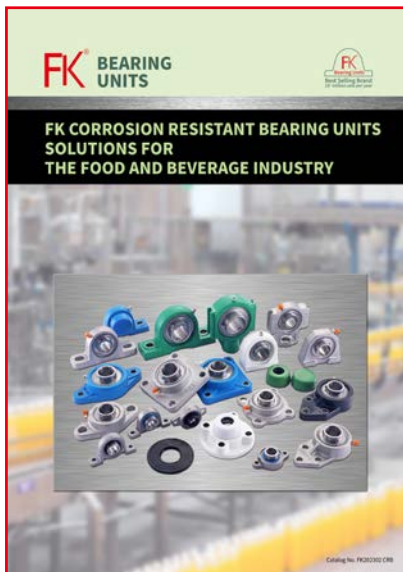

FK食品级带座轴承  
FK CORROSION RESISTANT BEARING UNITS



FK农机轴承  
FK SOLUTIONS FOR AGRICULTURE

# FK包装 FK Package



## 标准 Standard



## 风机 AH

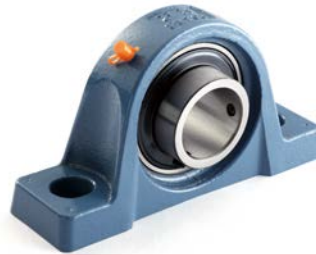

## 农机 AGRI



## 食品 FOOD GRADE



## MZD ECO





泛科

带座轴承专家与应用解决方案代表供应商  
Bearing Units Expert and Leading Supplier

## FK New Generation Factory

Automatic production of Whole Industry Chain Floor area total 166,800 sqm

### FK新一代工厂

占地166800平方,全产业链自动化生产



## Raw material storage

168 sizes steel tube stock location

### 原材料库存

168种型号钢管库存



## Production/生产

Monthly capacity 2 millions set insert bearing rings automatic turning line  
自动车加工月产200万套外球面轴承套圈



AICHELIN, atmosphere roller hearth furnace (salt bath hardening)  
爱协林可控气氛辊底式炉热处理生产线(盐浴淬火)



Automatic grinding line  
自动磨加工生产线



12 x automatic assembly line  
12条自动外球面轴承装配线



5 x automatic casting line / 5条自动造型铸造线



P/F/FL/FC/PA automatic machining line  
 P/F/FL/FC/PA 轴承座自动机加工生产线





泛科

带座轴承专家与应用解决方案代表供应商  
Bearing Units Expert and Leading Supplier

UCP/F/FL automatic assembly & packing line / UCP/UCF/UCFL带座轴承自动装配包装生产线



## Finished product storage

4000 European pallet for schedule order stock

成品库存

4000个欧洲标准托盘库存，供客户计划订单用



# 各种不同原材料的轴承座 Housings with various raw materials



灰口铸铁  
Casting iron



球墨铸铁  
Ductile iron



橡胶  
Rubber



铸钢  
Casting steel



工程塑料  
Thermoplastic



锻造钢  
Forging steel



锌铝合金  
Zinc alloy



冲压钢板  
Press steel



不锈钢  
Stainless steel

# FK各种不同的外球面轴承 FK All kinds of insert bearings



# 欢迎莅临泛科轴承集团交流指导

## Warmly welcome you to visit FK Bearing

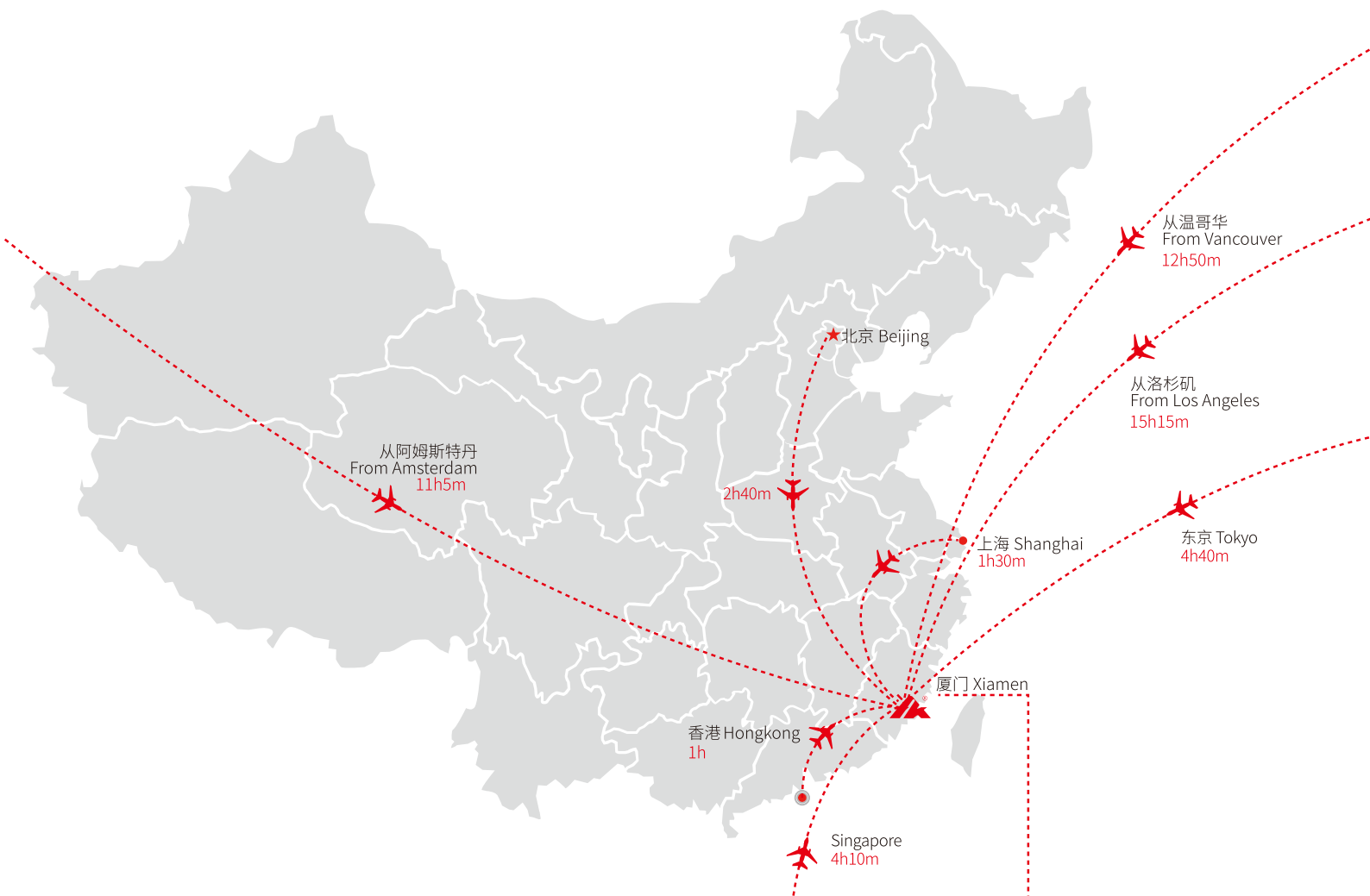

h表示小时

*h means hours*

m表示分钟

*m means minutes*

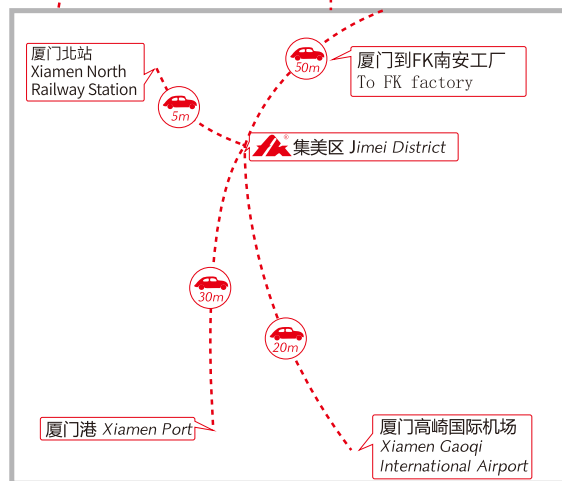

地址：福建省南安市雪峰经济开发区雪梅大道99号

Address: No.99 Xuemei Road, Xuefeng EDZ, Nanan 361021 China

Tel: 0592-6689010 Fax: 0592-6689009

E-mail: [export@fk-bearing.com](mailto:export@fk-bearing.com) [www.fk-bearing.com](http://www.fk-bearing.com)